

WORKSHOP SOLUTIONS

INTELLIGENT DIAGNOSTICS LIVE ON **TRITON D8™**

EVERYTHING YOU NEED - NOTHING YOU DON'T!

★
**ASK ABOUT
TOOL BONUS!**

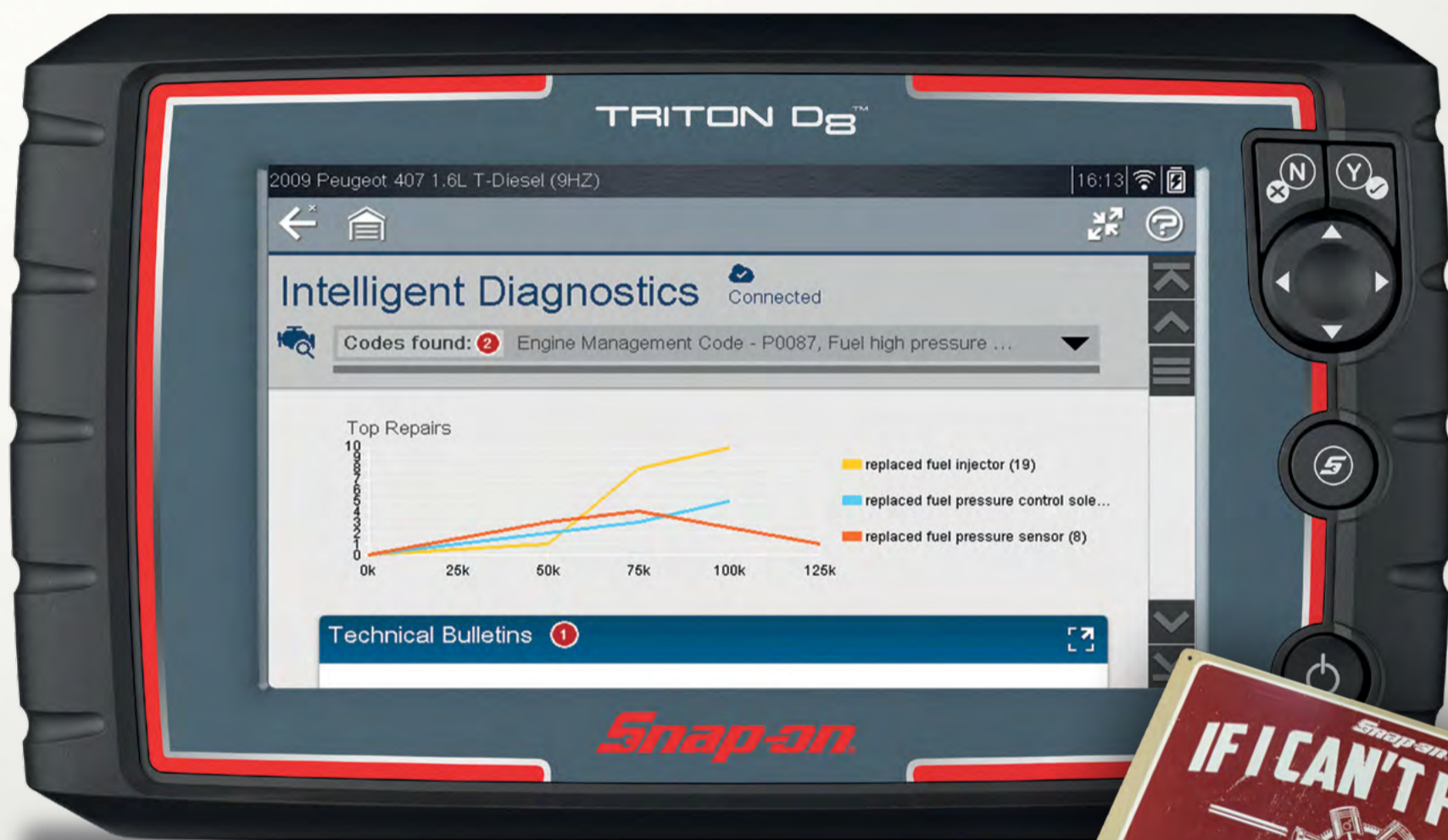

FREE GIFT PACK!

WHEN YOU BUY TRITON-D8 ON
SUBSCRIPTION*

INCLUDES:

- METAL SIGN
- KEY RING
- DIAGNOSTIC TOOL STYLUS



*OFFER AVAILABLE WHILST STOCKS LAST.

Snap-on
**INFORMATION
SYSTEM**

LOYALTY DISCOUNT!

PLUS, BUY TRITON-D8 ON SUBSCRIPTION, AND GET A SPECIAL DEAL ON A 2-USER SNAP-ON INFORMATION SYSTEM DESKTOP LICENSE!

GIVING YOU CRITICAL REPAIR INFORMATION INCLUDING...

- WIRING DIAGRAMS
- OEM TECHNICAL SERVICE BULLETINS
- SERVICE GUIDES AND DETAILED MAINTENANCE PROCEDURES
- REPAIR TIMES AND DATA
- OEM RECALLS AND CASE STUDIES

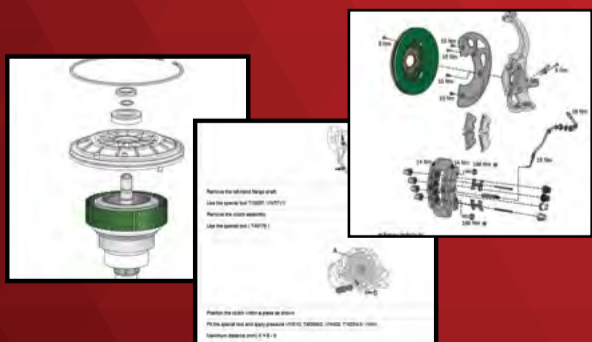

Find us on



PLITWSEQ

NOVEMBER - DECEMBER 2019

Snap-on

CALLING ALL LOYAL SOLUS ULTRA CUSTOMERS!

GET £1,200 FOR YOUR OLD UNIT! WHEN YOU UPGRADE TO A SOLUS EDGE!

MAKE SURE YOU CONNECT TO WI-FI FOR FULL FUNCTIONALITY!



ASK ABOUT SURETRACK™ EXPERT INFORMATION**

★ TAKING TRADES!

**SureTrack™ is only available with the latest software and wi-fi access.



WE'RE EXTREMELY PROUD TO BE RECIPIENTS OF **TWO QUEEN'S AWARDS FOR ENTERPRISE!**

In 2019 Snap-on was awarded with two prestigious Queen's awards for enterprise – the first award is for Innovation in recognition of the SureTrack™ repair information software and the second award is for International Trade in recognition of sales and support for diagnostic platforms in Europe.



INTELLIGENT DIAGNOSTICS
LIVE ON **ZEUS™**

**TOP OF THE RANGE DIAGNOSTIC TOOL,
PACKED WITH GREAT FEATURES...**

INCLUDES INTELLIGENT DIAGNOSTICS, SNAP-ON INFORMATION SYSTEM & 4 CHANNEL LAB SCOPE!*



ASK FOR MORE DETAILS!

*A data plan subscription and internet connection are required to access Intelligent Diagnostics and the Snap-on Information System.

Snap-on

INFORMATION SYSTEM

CHECK OUT WHAT'S NEW IN THE LATEST Q4 SIS RELEASE!

★
NEW!

THE LATEST UPDATES TO OUR OEM TECHNICAL INFORMATION SYSTEM INCLUDE...

- ✓ 19 NEW MODELS ADDED FROM POPULAR UK MANUFACTURERS
- ✓ 80 NEW UNIQUE SMARTCASE BULLETINS
- ✓ 265 NEW TECHNICAL SERVICE BULLETINS
- ✓ 175 NEW RECALLS
- ✓ COMPREHENSIVE ELECTRONICS UPDATE – MORE COMPONENT LOCATIONS AND MORE SYSTEMS DIAGRAMS
- ✓ MAINTENANCE AND REPAIR DATA UPDATE – MORE MAINTENANCE PROCEDURES AND REMOVAL/INSTALLATION MANUALS

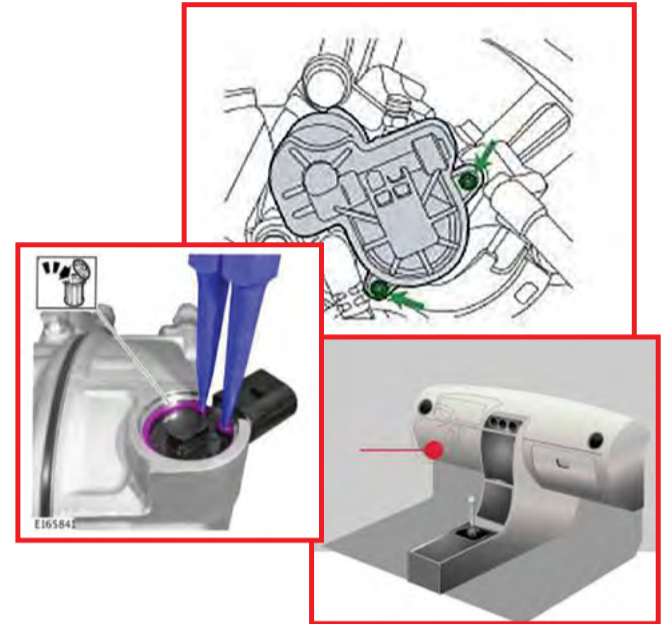

WHY CHOOSE SNAP-ON INFORMATION SYSTEM?

TWO LICENSES INCLUDED



PACKED WITH MORE CONTENT THAN THE LEADING COMPETITORS



FEATURES THE MOST ADVANCED TECHNICAL DATA SOLUTIONS FOR THE AUTOMOTIVE MARKET



CALCULATE REPAIR TIMES AND PARTS COSTS TO PRODUCE A CLEAR AND ACCURATE ESTIMATE FOR YOUR CUSTOMERS



ASK ME FOR MORE DETAILS!



THE NEW THERMAL LASER...

COMPACT, PRECISE AND PACKED FULL OF FEATURES!

EETHGB311A

- Thermal laser function pinpoints exact location of fault
- Laser temperature readings from -18°C to 982°C
- Thermal image blending over camera
- Store hundreds of images internally for reference

COMPACT 2.8" COLOUR DISPLAY –
ALLOWS IMAGING IN RESTRICTED
AREAS!

**THE POWER OF A THERMAL
IMAGER COMBINED WITH LASER
TECHNOLOGY!**

★ **ASK FOR A DEMO TODAY!**



WORKSHOP ESSENTIALS



40-PC 1/4" Stubby Bit Socket Set
BLPBSS40

- Set includes 10 metric bit sockets (2–10 mm), 10 imperial bit sockets (5/64"–3/8"), 10 Torx® tamper-resistant bit sockets (TP8–TP50), 6 XZN triple square bit sockets (XZN4–XZN12), 2 Phillips® bit sockets (#1 and #2) and 2 flat tip bit sockets (1/4" and 3/8")

A GREAT MULTI-PURPOSE SET!

£149.00 Excl. VAT



8 Cylinder Diesel Return Flow Kit
ITCDRF-KITB

£161.20 Excl. VAT

- Quickly identify faulty injectors – measure the overflow (spill or return) of diesel from each injector
- Special fuel resistant pipes do not kink, ensuring accurate fuel measurement
- Unique calibrated measuring block – allows quick fill and evacuation of fuel

COVERS UP TO 8 CYLINDER VEHICLES!

Injector Harness Tester Set
FID8838A

- Each tester plugs into solenoid harness to identify electrical or fuel system malfunctions

INCLUDES 8 TESTERS AND INJECTOR HARNESS EXTENSION!

£66.00 Excl. VAT



6-PC 3/8" 6pt Metric Swivel Ball Extension Socket Set
206PFSXM

£232.00 Excl. VAT

- Set includes 6 metric swivel ball extensions (10–15 mm)



Brake Caliper Press
BTCP500

- Works on twin and quad piston fixed calipers, as well as single and twin piston floating calipers
- Reverse lever allows for easy change from spreading to retracting

£50.00 Excl. VAT



Small Brake Caliper Press
BTCP400

- Ratcheting mechanism allows for fast and easy retraction of single and multiple piston calipers

£50.00 Excl. VAT



Wheel Alignment Wrench
GAW1290

- Use on alignment bolts for Audi, VW, Porsche, BMW and Mini vehicles

£68.00 Excl. VAT



40° Brake Tool Prybar
MPBS1140AO

£35.00 Excl. VAT

GREAT FOR HIGH VOLUME TYRE/BRAKE WORKS!



Truck Wheel Pan
TWP8

£15.00 Excl. VAT



4-PC Wheel Hanger Set
WHS4

- Aids in the removal and installation of wheels where wheel studs are not used

£69.00 Excl. VAT



4-PC J.I.S Screwdriver Set
ITCJIS

£30.00 Excl. VAT



i What is a J.I.S cross headed type screw?

J.I.S

- J.I.S stands for Japanese Industrial Standard and are now fitted to many Japanese import vehicles and motorcycles
- J.I.S screw heads are identified by a small dimple near the cross head opening

PHILLIPS®

USING THE CORRECT SCREWDRIVER PREVENTS DAMAGE TO SCREW HEADS!

7-PC Power Fastener Extractor Set
BET7

- Includes 3/16" – 1/2" power extractors

£51.00 Excl. VAT



Wheel Hub Lock Tool
WLT1

- Eliminates need for assistant to hold brake pedal while axle nuts are removed or installed

£29.00 Excl. VAT



Terminal Cleaner
BTC8A

£8.00 Excl. VAT



Terminal Brush
BTC3A

£10.00 Excl. VAT



Terminal Cleaner with Side Terminal Brush
BTC7B

£18.15 Excl. VAT



Battery Crimp Tool
BTCR1

£44.00 Excl. VAT



GIVING YOU THE REACH... AND THE POWER!

NEW!

14.4V 1/4" Long Neck Cordless Ratchet with 1 Battery
CTR717WB / GWB / OWB

- High-speed for quick fastener removal and installation
- Variable-speed trigger for precise control
- Built-in LED headlight to illuminate work area
- Includes tool and 1 battery

SPECIFICATION	
Torque Output (Nm)	Up to 47
Free Speed (RPM)	350

4.5" NECK FOR GREATER ACCESS!

**AVAILABLE IN RED,
GREEN & ORANGE!**

**47NM OF TORQUE OUTPUT
- THE PERFECT TOOL FOR
APPLICATIONS WITH
FASTENERS 10MM OR
SMALLER!**

**KIT ALSO
AVAILABLE!**
CTREU717 / G / O



18V Lithium Cordless Angle Grinder Body Only
CTGR8850DB

- Low profile head gives excellent access
- Rotating battery can be kept out of the way
- Electronic safety clutch
- 7 position safety guard

**GREAT FOR METAL FABRICATION &
AUTO BODY REPAIRS!**

**ASK ABOUT MY OSHA COMPLIANT
VERSION WITH SAFETY SWITCH!**
CTGR8855DB



MAKE AN IMPACT! TAKING TRADES ON OLD IMPACT WRENCHES!

**AVAILABLE IN RED, GREEN,
ORANGE & HI-VIS!**

NEED A LITTLE EXTRA?

3/4" Air Impact Wrench with Long 3" Anvil
MG1250L
FOR MORE REACH!



3/4" Air Impact Wrench with Extra Long 6" Anvil
MG1250XL
FOR EVEN MORE REACH!



3/4" Air Impact Wrench with Pinned Anvil
MG1250P
**HOLDS SOCKETS MORE
SECURELY - GREAT FOR OVERHEAD USE!***



3/4" Air Impact Wrench
MG1250/G/O/HV

SPECIFICATION	
Maximum Torque (Nm)	Up to 1,694
Blows per Minute (BPM)	1,050
Free Speed (RPM)	6,200



POWERFUL TWIN HAMMER MECHANISM

ANVIL STOP FEATURE PREVENTS THROWING OF SOCKETS AND FASTENERS AFTER RELEASE OF TRIGGER

**★ GET
MINIMUM
£150 TRADE-IN!
★**



**16-PC Impact Torx®
Hex Socket Set**
ITCIDS

£159.00 Excl. VAT

- Extensive set with many, very popular impact socket types for commercial vehicles
- Impact version for machinery operation

*NOT RECOMMENDED FOR WHEN SOCKET SIZE NEEDS TO BE CHANGED FREQUENTLY

ESSENTIAL KIT FOR TPMS SENSORS!



Tyre Pressure Sensor System TPMS4

Key features for the TPMS4 include:

- Test and re-learn tyre pressure monitoring systems
- Program aftermarket sensors
- Capture sensor data
- Print sensor information

ADD-ON TO YOUR DIAGNOSTIC TOOL FOR EXTENDED COVERAGE & FUNCTIONALITY!



15-PC Tyre Pressure Monitoring System Tool Kit TPMS300

- Kit contains: TPMS adjustable torque screwdriver, tyre valve removal tool, 1/4" 6pt deep sockets (11 & 12mm), 1/4" hex-to-1/4" square adaptor, magnetic bit holder, 3 torx power bits, 3 torx hex shank bits, tyre valve bit, 7" wide prying/smoothing tool and non-marring pick

PERFECT FOR WORKING WITH BOTH PLASTIC AND ALUMINIUM SENSORS!

ALREADY OWN A TPMS4? ASK YOUR FRANCHISEE ABOUT GETTING THE LATEST SOFTWARE!

11-PC 15° Offset Slimline Open End Wrench Set LTAM811

- Contains a wide range of sizes: 6-36mm
- Great for brake calipers, truck air lines, tappet adjustment, in-line fuel filters and much more!

SLIM PROFILE - SPECIALLY DESIGNED FOR GETTING INTO TIGHT SPACES!

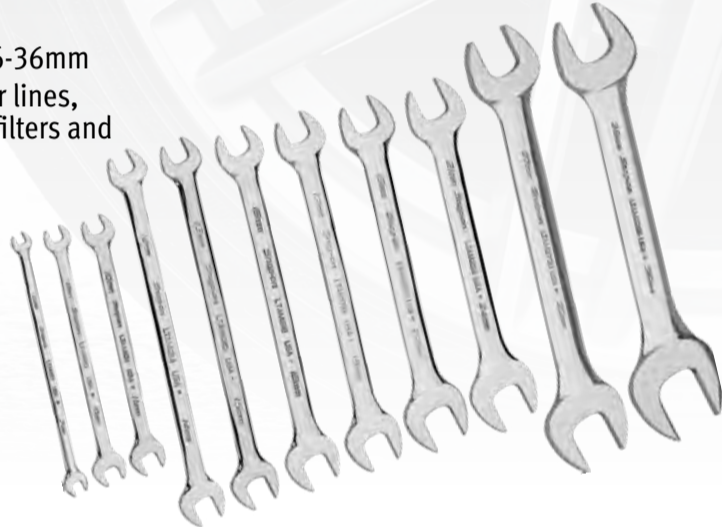

£249.00 Excl. VAT

4-PC Metric Ratcheting Combination Wrench Set BOERM704

- Contains sizes 21, 22, 24 & 25mm
- 15° offset box head for knuckle clearance
- 4.5° - 5° ratcheting arc - great in restricted areas

£126.00 Excl. VAT



FDXTM FLANK DRIVE[®] XTRA SOCKETS

NOW AVAILABLE IN IMPERIAL!

10-PC 1/4" 6pt Imperial Deep FDX Socket Set 110YSTMY



- Both 1/4" sets include sizes 3/16" - 9/16"

10-PC 1/4" 6pt Imperial Shallow FDX Socket Set 110YTMV



★ ASK ABOUT THE 5 KEY FEATURES OF FDX!

11-PC 3/8" 6pt Imperial Deep FDX Socket Set 211YSFY



3/8"

- Both 3/8" sets include sizes 1/4" - 7/8"

11-PC 3/8" 6pt Imperial Shallow FDX Socket Set 211YFSY



3/8" Metric/Imperial Magnetic Socket Holder 38MSKTHRED / GRN / ORG / BLK



AVAILABLE IN RED, GREEN, ORANGE & BLACK!

£42.00 Excl. VAT

WINTER IS COMING!

ALL CLOTHING AVAILABLE IN MEDIUM, LARGE, X-LARGE & XX-LARGE

REMOVABLE HOODS

Grey/Black Camo Pulse Bomber Jacket
CHKJ3840-M/L/XL/XXL

Red Pulse Bomber Jacket
CHKJ3839-M/L/XL/XXL

INTERIOR
DETAIL



HEAVYWEIGHT, QUALITY CONSTRUCTION!

BUY THE HOODY...
GET THE T-SHIRT FREE!



AVAILABLE
IN BLACK
& GREY!



LGHDYTSMB / LB / XLB / XXLB - Black
LGHDYTSMBG / LG / XLG / XXLG - Grey



Workshop Overalls
LOGOOVL5-M / L / XL / XXL



Heavy Duty Sports Jacket
LGHDSPJA-M / L / XL / XXL



Heavy Duty Body Warmer
LGHDBWA-M / L / XL / XXL



Heavy Weight Fleece
LGHWFLCA-M / L / XL / XXL



Heavy Duty Winter Jacket
LGHDWJA-M / L / XL / XXL



Become a franchisee for less than £12k Work for yourself, not by yourself, with a Snap-on franchise

Snap-on is the world's number one tool brand and it's also a great business opportunity! Take control of your destiny - for half the usual start-up costs - with our Jump Start package. You pay just £11,755 and we pay the rest. As a franchisee, you will own and run your own iconic showroom on wheels. We have over 400 franchisees who come from all walks of life - many are former technicians or mechanics.

- ▶ Full training and a lifetime of support
- ▶ Keep 100% of your profits
- ▶ Join a network of likeminded people
- ▶ Enjoy more freedom and flexibility

"I'd been a Snap-on customer for years and had always been interested in the franchise opportunity, but it was the promotional price that encouraged me to finally decide to just go for it."

Alex McNellan, franchisee

This is your opportunity to build a profitable business, doing what you love.
There's only one question really... What are you waiting for?



£12k offer available nationwide

For a limited time only - don't miss out!

www.snaponfranchise.co.uk

TEST, DON'T GUESS!



GREAT DEALS AVAILABLE!

Dual View Video Inspection Scope BK6500DUAL55

- 5.5mm diameter imager - fits most injector ports
- Digital video capture
- Rechargeable lithium battery
- USB port for mass storage transfer

**SEE FORWARD OR
90 DEGREES TO
THE SIDE WITH
ONE TOUCH!**

Master Multimeter "Y" Terminal Adaptor Kit MTTL900-KIT

- Unique "Y" adaptor enables testing of single terminal or inline testing of a circuit or terminal harness
- Non-intrusive circuit testing with a banana jack adaptor for DMM test lead or circuit tester connection
- Use with EEDM multi-meters or EECT circuit testers

**FOR TESTING
12V & 24V DC
TERMINALS!**

£248.00 Excl. VAT



ASK ABOUT MY RANGE OF TEST LEAD ACCESSORIES!

1. M TTL430 - Back Probe Set of 3
2. M TTL575 - DMM Test Lead Set
3. M TTL700 - Test Lead Kit with Interchangeable Tips
4. M TTL7002 - Screw-on Banana Plug Adaptors
5. M TTL7008 - Medium Spade Terminal Prod Kit
6. M TTL7006 - 2-PC Micro Tip Back Probe Set
7. M TTL7007 - Insulated Back Probe Set
8. M TTL825 - 3-PC Modular Test Lead Set
9. M TTL720 - 20-PC Back Probe Pin Kit
10. M TTL500 - Multi-purpose Test Lead Kit
11. M TTL725 - Hard Tip DMM Test Lead Set
12. M TTL800-3A - Alligator Clips (Positive/Negative)

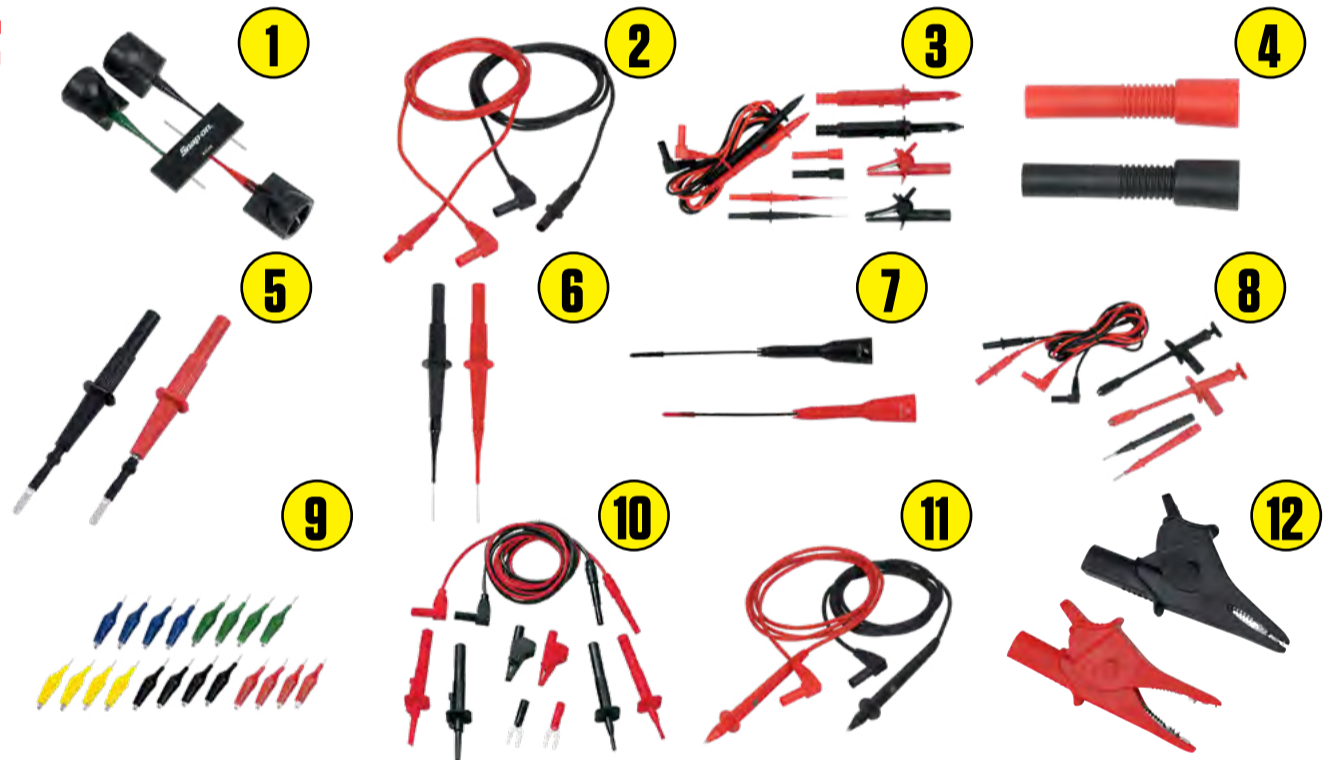

OBD-II Break Out Box BPBOB

- Tests vehicle data link connector (DLC) for any abnormality such as shorting and reverse polarity at the pins before the diagnostic tool (scanner) is plugged into the DLC - this helps to prevent damage to your scan tool

£195.00 Excl. VAT



**3 PIN CONFIGURATIONS
ALLOW EASY TESTING OF
ALL THREE FUSE SIZES
WHEN USED WITH YOUR
MULTI-METER!**



Voltage Reference (VR) Probe BPVRPROBE

- Allows input voltage from 0.5V – 7V in 0.5V increments to be sent to a sensor or circuit
- Bypasses components and sends desired voltage back to ECU, allowing you to test for faulty components/sensors
- Suitable for use on 12 and 24V systems

Applications include:

- Accelerator pedal voltage up to 5V
- EGR signal voltage up to 5V
- Cam & crankshaft sensors
- MAP & MAF sensors
- Parking sensors
- Pressure, temp & TPS sensors

£150.00 Excl. VAT



EASILY TEST FOR FAULTY COMPONENTS AND SENSORS!

BOOST YOUR BUSINESS

12V Battery Booster Pack BPBB2500UK

- High current battery provides 2,500 amps peak starting power
- 375 cranking amps / 280 cold cranking amps
- Reverse polarity protection
- LED battery gauge for quick assessment on state of charge



GREAT FOR CARS, LIGHT TRUCKS AND RECREATIONAL VEHICLES!

£259.00 Excl. VAT

12V Engine Starter+ EEJP600-U

- 350 cranking amps provided at 0°C, with 290 cold cranking amps provided at -18°C
- Digital display indicates internal battery % of charge, DC voltage, plus vehicle battery voltage



DELIVERS 290 COLD CRANKING AMPS!

ASK ABOUT THE 12/24V HEAVY DUTY ENGINE STARTER+!
(EEJP600V24-U)

12/24V Booster Pack SRN1224A

- 2 x 12V 22Ah batteries
- Cranking amps - 1,200/700
- Peak 3,200/1,600 amps
- Reverse polarity buzzer



£752.30 Excl. VAT

GREAT FOR SMALL COMMERCIALS!

12V Booster Pack SRN80012V

- 2 x 12V 20Ah batteries
- Cranking amps - 800
- Peak 2,400 amps
- Reverse polarity buzzer



£597.15 Excl. VAT

GREAT FOR BIG 12V DIESELS!

12/24V Heavy Duty Booster Pack SRN1224HD

- 2 x 12V 26Ah batteries
- Cranking amps - 1,100/1,100
- Peak 3,500 amps
- Reverse polarity buzzer



£1,373.25 Excl. VAT

GREAT FOR BIGGER COMMERCIALS!

Booster Pack Trolley SRNTROLLEY

- Move booster packs around the workshop with ease

£113.55 Excl. VAT

USE WITH THE SRN80012V, SRN1224A & SRN1224HD



NB: BOOSTER PACK NOT INCLUDED

TECHANGLE® ELECTRONIC TORQUE SCREWDRIVERS

A TECHMS80F - 1/4" Female Hex Drive*
A TECHMS80M - 1/4" Male Drive

*Compatible with Snap-on 1/4" hex screwdriver bits (not included)



- Choose 1/4" Female Hex or Male Drive



- Torque range: 0.45 - 9Nm

- 3 modes of operation - Torque, Angle, Torque then Angle

- 6 units of measure - in-lbs, in-oz, ft-lbs, Nm, Kg-cm, cNm

- 4 modes of indication - LCD, audible beep, vibration and 360° progressive LED

FOR PRECISION LOW TORQUE APPLICATIONS SUCH AS TPMS SENSORS!

★ ASK ME FOR A DEAL!

1/2" TQ Series Flex-Head Torque Wrench TQFRN350E

- Flex-head provides knuckle and obstruction clearance

- Torque range: 60 - 350Nm

- Cushion grip for comfort and control

- Torque value is shown in display window

- Designed for measuring torque in a clockwise direction only (not reversible)

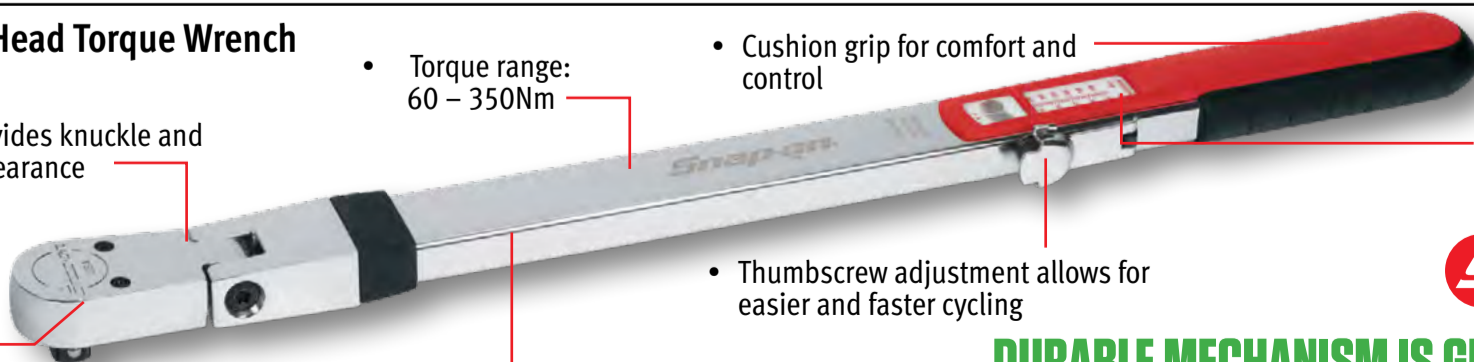

- Unique split-beam measuring element gives accuracy and durability

- Thumbscrew adjustment allows for easier and faster cycling

£357.65 Excl. VAT

DURABLE MECHANISM IS GREAT FOR TOUGH ENVIRONMENTS LIKE FAST-FIT TYRE SHOPS!

KEEP IT TIDY!

★ **NEW!**

Two Stage Wet/Dry Vac SOVAC16UK

- 60L Stainless Steel tank
- Large drain port with disposal hose
- Extra-long 7.5m cord
- Includes utility nozzle, dust brush and crevice tool

**GREAT FOR CAR
DETAILING, GLASS IN
DOORS, LEAVES UNDER
BONNET, BODY SHOP
CLEAN UP & MUCH
MORE!**

**FREE TRIPLE PACK
OF VAC BAGS!**

SOVAC16UK-4



★
**ASK ME FOR
A DEAL!**
★

EXPAND YOUR 40" HERITAGE STACK!

Heritage Locker

KRA2012AK/PC/PCM/PJJ/PJK

- Over 10,000 cubic inches of storage space
- 4 internal drawers | 3 internal shelves
- Double wall construction - for strength and durability

**AVAILABLE IN RED,
BLACK, ROYAL BLUE,
EXTREME GREEN &
ELECTRIC ORANGE**



12" Power Tool Rack*

KAS12APWRPC



£65.00 Excl. VAT

Glove Dispensing Rack*

KAGLVHLDR

- Holds glove boxes that are 3-4" wide



£30.00 Excl. VAT

Prybar Rack

KAPR17A / PC

- Fits all KRSC43/46 carts, Heritage and Classic Series roll cabs



**AVAILABLE IN
RED & BLACK!**

£120.00 Excl. VAT

12" Drop-In Screwdriver Rack*

KASR12APV

- Holds up to seven screwdrivers or other tools



£14.00 Excl. VAT

12" Hammer Rack*

KAHR12PV

- Holds 3 hammers



£37.00 Excl. VAT

12" T-Handle Rack*

KATR12PV



£17.00 Excl. VAT

Flat Utility Shelf*

KAS12APV



£17.00 Excl. VAT

Spray Can Rack*

KAT18APV | KAT12APV

**AVAILABLE IN
12" & 18"**

FROM
£21.00 Excl. VAT



*For mounting on Snap-on Slots-N-Dots™ system

LIGHT UP YOUR TOOLBOX!

- Magnetic mounting
- Magnetic switch allows light to turn on/off depending on door position
- Can also be operated by remote control



5ft Light Bar with Remote Control
ECTSA319RCUK

4ft Light Bar with Remote Control
ECTSA289RCUK

1.5ft Light Bar with Remote Control
ECTSA109RCUK

★ **NEW!**

SUPPORTING YOUR BUSINESS!



10 Tonne Body Jack Set
SNXPR10

£255.00 Excl. VAT

- 10 tonne capacity kit includes: 1 x hydraulic unit, 4 x extensions (4, 10, 18 and 27"), spreader and full selection of attachments in custom-fitted, rugged and wheeled storage case
- Pumps rated from 8,000–10,000 psi
- Great for crash repair - straightening out chassis and bodywork

500kg Engine Support Bar
SNXES500



- Length: 1,700mm
- Working Range (Width): 730 - 1,550mm
- Height Adjustment: 0 - 205mm
- For use when engine mounts have been undone - ideal when removing gearboxes and changing timing belts

£115.00 Excl. VAT

ADD SOME COLOUR TO YOUR WORKSHOP!

AVAILABLE IN BLACK, GREEN & ORANGE!

3 Tonne Service Jack
SNX3-4PBOPS/PG/PO



- Min height - 100mm, max height - 495mm



£218.15 Excl. VAT

3 Tonne Axle Stand Pair
SNX3JSRBOPS/NG/O



- Min height - 292mm, max height - 432mm



£53.40 Excl. VAT

2 Tonne Baby Beast Jack
SNX2CETJBOPS/NG/O



- Min height - 70mm, max height - 500mm



£169.15 Excl. VAT

5 Tonne Axle Stand Pair
SNX5JSRBOPS/NG/O



- Min height - 394mm, max height - 625mm



£89.60 Excl. VAT

UNDER PRESSURE?



Combined Diesel Fuel Bleed and Pressure Test Kit
ITCFTK

Kit contains:

- 2 x Pressure gauge (1-5 bar and 1-15 bar)
- Hand pump unit with hose and quick connectors
- 4-way connector with quick release fitting
- T-piece connectors (6mm, 8mm, 10mm)
- 10 x 2-PC Adaptor Sets (8 x 20mm), (8 x 30mm), (9.5 x 20mm), (10 x 20mm) and (10 x 30mm)
- 2-PC Adaptor set (NG8 type)
- 3/8" Double-sided quick coupling & adaptors
- Quick connect fitting with shut valve and drain pipe
- Gauge hanger
- Drained fluid bottle

★
ASK ME FOR A DEAL!
★

BREAK INTO FUEL LINES TO PURGE AIR OR CHECK SYSTEM PRESSURE!

Easy Mover Vehicle Dolly
YASEM2

- 2 dollies permit a full 180° pivot
- 4 dollies will place the vehicle on a 360° rolling platform



£199.00 Excl. VAT

RACK ATTACHMENT ALSO AVAILABLE!
YASEM2R



ALLOWS VEHICLES TO BE MOVED QUICKLY, EASILY AND SAFELY WITHOUT ENTRY OR THE NEED FOR KEYS!

Flat-Oval Adjustable Creeper
JCW67R/G/O/BL

£180.00 Excl. VAT



AVAILABLE IN RED, GREEN, ORANGE & BLACK!

SUN EZ ADAS RECALIBRATION SYSTEM

INNOVATION. PRECISION. SPEED. SIMPLICITY.

Are you ready for a revolution in Advanced Driver Assistance Systems Recalibration?

Key features include*:

- Precision tools
- Sophisticated design
- Multi-position laser measurement
- Easy laser positioning guides
- Intuitive target adjustment
- Faster set-up times
- Small footprint and few components for ease of movement and storage
- Reduces risk of recalibration errors



MAXIMISE YOUR PROFIT!

By performing four-wheel alignment prior to ADAS recalibration

*Some exceptions may apply

V1200 ELITE



Fully Mobile Wheel Alignment System

- Installation, measurement, maintenance and service made easy — a compact design that requires little storage space even in front of the lift

V2200



Imaging Wheel Alignment System

- An intuitive interface, easy-to-use software and customisable workflows for advanced alignment service without the need for specialised training

V2400



Wireless Wheel Alignment System

- Unmatched accuracy and user-friendly features in a conventional design for one of the most advanced alignment systems on the market

V3400



Wireless Three-Camera Wheel Alignment System

- Precision and ease of use for the unbeatable accuracy that high-volume alignment shops and dealerships require

★ **SPEAK TO YOUR FRANCHISEE FOR MORE DETAILS!** ★

THE COMPLETE COMMERCIAL DIAGNOSTICS SOLUTION! THE BEST JUST GOT BETTER!



Key features include:

- Toughbook with 14" screen
- Military standard, drop-proof design
- USB and HDMI ports
- Industry-leading trailer coverage
- Interactive wiring diagrams
- Manual programming
- Truck, bus and trailer cables
- System overviews
- Cloud-based accessibility
- Built-in job report
- Free ETM module (worth: £970)
- 1-year software updates
- UK based product support

UPGRADE YOUR TABLET!

YOU CAN BE LIFTED!



Key features include:

- 4.0 tonne capacity
- Full site survey prior to installation (including floor inspection)
- Includes ultra low profile arms to lift low skirted vehicles
- Base plate design

FOR ONLY £2,996 Excl. VAT
LIMITED STOCK AVAILABLE!

TYRE AND WHEEL PACKAGE FOR THE PROFESSIONALS!



Monty 8300s Tyre Changer
8300S

- Centre post, lever design
- SMARTSPEED - automatically selects the best speed for the operation being performed
- Total clamping range up to 44"*



Tyre Changer
STC5545

- Low-profile cabinet design
- ProSpeed – automatically selects the best speed for the task
- Total clamping range up to 30"*

Geodyna 7340L Wheel Balancer
7340L

- geoTOUCH™ 10" graphical touch-screen display
- 2D SAPE, measure wheel offset and rim diameter in one step
- EasyAlu, automatic weight mode recognition
- Smart Sonar, automatic rim width acquisition
- Easyweight, accurate positioning of adhesive weights



Wheel Balancer
SWB340L

- Clear touch-screen display
- 2D SAPE, measure wheel offset and rim diameter in one step
- EasyAlu, automatic weight mode recognition
- Smart Sonar, automatic rim width acquisition
- Easyweight, accurate positioning of adhesive weights



*With additional adaptors

★ **SPEAK TO YOUR FRANCHISEE FOR MORE DETAILS!** ★

FREE STARTER PACK WHEN YOU BUY ANY FEATURED BELT DRIVE AIR COMPRESSOR*

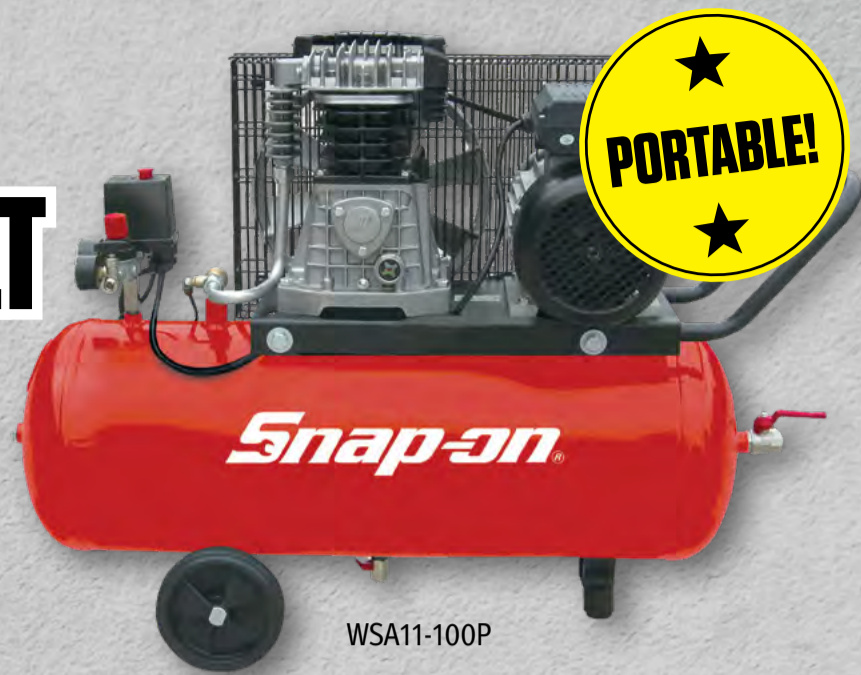

WSA11-100P



11-PC Starter Pack
WSCSP1

- Pack includes: 10 metre air hose and a range of male and female 1/4" & 1/2" BSP couplings



15-PC Starter Pack
WSCSP2

- Pack includes: 5 metre air hose, a range of male and female 1/4" & 1/2" BSP couplings, 1/2" Filter Regulator & 1/2" male to 1/4" male adaptor

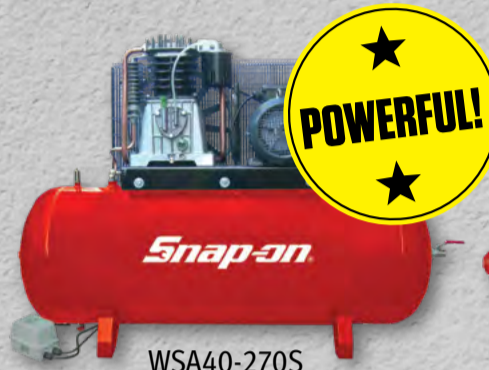

WSA40-270S



WSAP25-150S

TAKE YOUR PICK!

PART NUMBER	TANK SIZE	HP	INPUT POWER	MAX WORKING PRESSURE	AIR DISPLACEMENT	FREE AIR DELIVERED	PRICE	FREE STARTER PACK*
WSA11-100P	100 Ltr	2.5	230V 50Hz	145 PSI-10 Bar	11 CFM	7.7 CFM	£819.00 Excl. VAT	WSCSP1
WSA13-150S	150 Ltr	3.0	230V 50Hz	145 PSI-10 Bar	13 CFM	9.0 CFM	£921.50 Excl. VAT	WSCSP1
WSAV3-90P	90 Ltr	3.0	230V 50Hz	145 PSI-10 Bar	12.4 CFM	9.0 CFM	£1,230.00 Excl. VAT	WSCSP1
WSA17-200S	200 Ltr	4.0	230V 50Hz	145 PSI-10 Bar	17.7 CFM	13.2 CFM	£1,434.00 Excl. VAT	WSCSP2
WSA20-200S	200 Ltr	5.5	400V 3 Phase	145 PSI-10 Bar	21 CFM	17 CFM	£1,741.50 Excl. VAT	WSCSP2
WSA30-270S	270 Ltr	7.5	400V 3 Phase	145 PSI-10 Bar	29.8 CFM	23 CFM	£2,049.00 Excl. VAT	WSCSP2
WSA40-270S	270 Ltr	10.0	400V 3 Phase	145 PSI-10 Bar	39 CFM	29 CFM	£3,074.00 Excl. VAT	WSCSP2
WSAT28-250S	250 Ltr	2 x 3.0	230V 50Hz	145 PSI-10 Bar	26 CFM	18 CFM	£2,049.00 Excl. VAT	WSCSP2
WSAP25-150S	150 Ltr	9.0	Petrol	145 PSI-10 Bar	25 CFM	20 CFM	£3,176.50 Excl. VAT	WSCSP2

*Offer available whilst stocks last

WORKSHOP ESSENTIALS!



ESSENTIAL FOR BLEEDING MODERN ABS SYSTEMS!

Pressure Brake Bleeder & Trolley
ALB570HTSN

£499.00 Excl. VAT

- 3 meter extended hose
- Robust trolley to prevent spillages
- Pressurised functionality recycles fluid
- Euro cap fits most applications



Diesel Space Heater
PROHEAT1

£852.65 Excl. VAT

- Plastic fuel tank - won't rust or contaminate fuel
- Use with paraffin or diesel without setting adjustments
- External fuel filter for less downtime and improved reliability
- 42 litre fuel tank - 11 hour run time
- 130,000 BTU output for powerful heating performance

PERFECT FOR HEATING YOUR WORKSHOP THIS WINTER!

★ NEW!

Air Operated Spring Compressor
BPAOSC

- Heavy duty pneumatic operated unit that gives a massive 2,400kg thrust force
- Ideal for all types of springs including compressing larger springs such as MPV's, 4x4's, Mercedes, Nissan Navara & light commercials
- Heavy duty triple bar safety cage that unless lowered and locked will not allow the machine to operate



ASK ME FOR A DEAL!

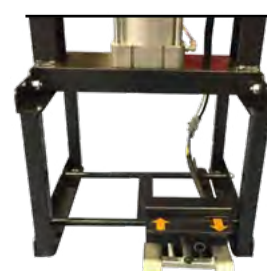

NEED EXTRA HEIGHT?

Air Operated Spring Compressor Extension Kit
BPAOSC-EK

- Lift height of spring compressor by 30cm

NEW COMBAT TAN TOOLBOXES!

WITH BLACKOUT DETAILS

BLACK LOGOS | BLACK TRIMS | BLACK CASTERS

32" 3 DRAWER ROLL CART

KRSC33APZS



Size: W32" x H43" x D20"
Cubic Inches: 9,591

40" 6 DRAWER ROLL CART

KRSC46HPZS



Size: W40" x H46" x D20"
Cubic Inches: 20,783

40" HERITAGE STACK

BOX20190CT2



Size: W40" x H58.5" x D20"
Cubic Inches: 24,746

55" CLASSIC 78 STACK

BOX20190CT1



Size: W55" x H68" x D24"
Cubic Inches: 45,252

NEW COLOURWAY!



FORD FIESTA XR2 MK1

RED WITH BLACK TRIMS
BOX2019DEC1

40" HOT HATCH HERITAGE ROLL CABS



PEUGEOT 205 GTI

WHITE WITH BLACK TRIMS
BOX2019DEC2



RENAULT CLIO WILLIAMS

MIDNIGHT BLUE WITH GOLD TRIMS
BOX2019DEC3

COMING IN DECEMBER!

• Size: W40" x H38.5" x D20"
Cubic Inches: 15,000

NEW TO THE UK!

ROLL CABS IN ALL YOUR FAVOURITE COLOURS. ALL AT ONCE.



VOLCANIC FLARE
BOX2019NOV1



PSYCHEDELIC
BOX2019NOV2



DEEP SPACE
BOX2019NOV3

- Size: W55" x H39" x D24"
Cubic Inches: 23,969

TAKING TRADES!



FEATURES...

HEAVY DUTY BEDLINER TOP.
PROVIDES AN EXTREMELY DURABLE WORK SURFACE.



SNAP-ON COLOUR SHIFTING ROLL CABS ARE HERE. One of the hottest looks on the street is now available in your workshop. The new Snap-on Colour Shifting Classic Series KRA2422 roll cabs feature special 3M® vinyl that shows a full spectrum of colour as light moves across them. Whether you prefer the Volcanic Flare, Psychedelic or Deep Space wrap, you're not just choosing a colour. You're choosing a mind-blowing rainbow.

ASK YOUR FRANCHISEE FOR MORE DETAILS!

